

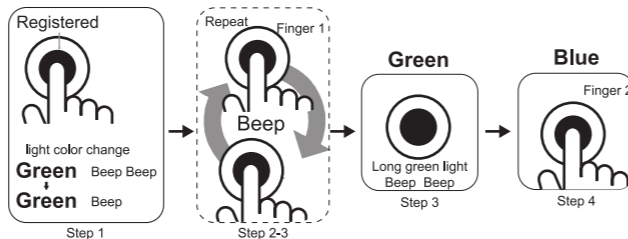

Standalone Cabinet Lock User Manual

1. How to add fingerprint (Max 100 fingerprints)

- Put a finger on sensor, green light with "Beep, Beep", holding, green light with "Beep", then remove(or press * for 2seconds, enter user password or master password and #,enter 4 #)
- Blue light, put a finger on, "Beep" then remove
- Put the finger on, a beep then remove; repeat until green light with "beep,beep" (The fingerprint is registered)
- Blue light, add more new fingerprints



2. How to change user password (Factory Setting: 1-2-3-4)

- Press * for 2 seconds, "beep,beep"
- Enter current user password (or master password) and #, "beep,beep"
- Enter 1#,"beep,beep"
- Enter new use password and #, "Beep, Beep", new use password enabled

* → "1 2 3 4" (Sample) → # → "1 # " → "0 0 0 0" (Sample) → #

3. How to change master password (Factory Setting: 5-4-3-2-1-5)

- Press * for 2 seconds, "beep,beep"
- Enter current master password code and #, "beep,beep"
- Enter 2#,"beep,beep"
- Enter new password and #, "Beep, Beep", new master password enabled

* → "5 4 3 2 1 5" (Sample) → # → "2 # " → "1 1 1 1" (Sample) → #

4. How to unlock

1. Password
 - Enter user password or master password and #, "beep,beep", unlocked
 - Pull door open

"0 0 0 0" (Sample) → #

2. Fingerprint
 - Put any registered fingerprint, "beep", holding, green light then "beep beep", unlocked
 - Pull door open

How to initialize the lock

- Insert E-Key
- Enter 11# , "beep,beep",system initialized
- Note: System initialized, all fingerprints deleted, user password: 1-2-3-4, master password: 5-4-3-2-1-5

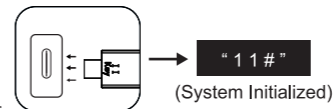

Other Function

UKey

- 1.Insert E-Key
- 2.Pull the door open

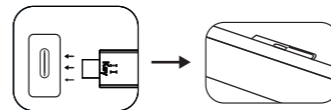

2. Low Battery Warning

- 1.If "Beep Beep ..." 6 sounds after door opened , it indicates low battery then change new battery in time
2. Note: Use 4XAA alkaline battery, not take Carbon battery

3. Outer Power Supply

- When low battery, can connect power bank or mobile plug for outer power supply
- After unlocked, change the battery immediately

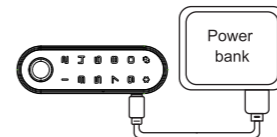

4. How to set mode

- Insert E-Key
- Enter 44#1# , automatic mode enabled
- Enter 44#2# , manual mode enabled
- Enter 44#3# , public mode enabled (by default)



5. How to lock

1. Individual Automatic Mode
 - Push the door closed, door locks automatically
2. Individual Manual Mode
 - Push the door closed
 - Enter #, latch comes out, locked
3. Public Mode
 - Push the door closed
 - Enter any password and #, "beep,beep"
 - Latch comes out, locked

Installation Instructions

1. Put the installation drawing on the door, approx. 38-40mm between the door frame and center hole (Picture 1), then drill the hole

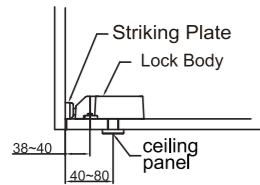

Picture 1

wire connection

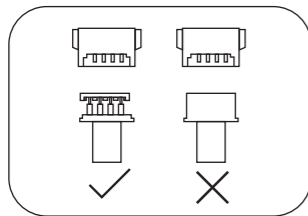

2. Install the front panel and lock body
Wire goes through the center hole and fix the front panel by screw M4X22, then connect the lock body, (Tide up the wire not crush), fix lock body by screw ST3.5X14.

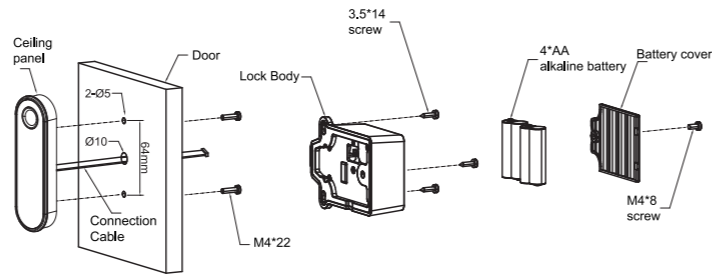

Picture 2

3. Fix the striking plate by screw ST3.5X18(Make sure latch works well)

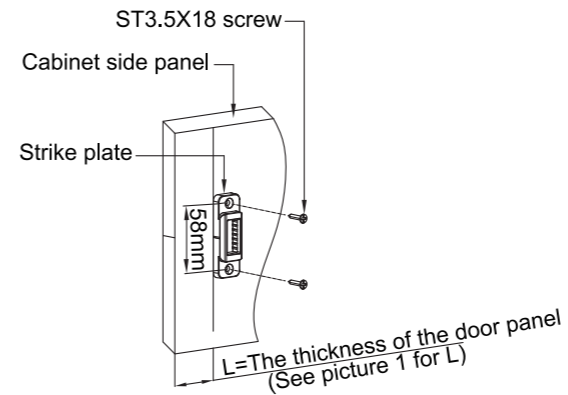

Picture 3

	Door Thickness(mm)	Phillips pan head Screw
	14mm~16mm	M4X20
	16mm~18mm	M4X22
	19mm~21mm	M4X25

INSTALLATION DRAWING

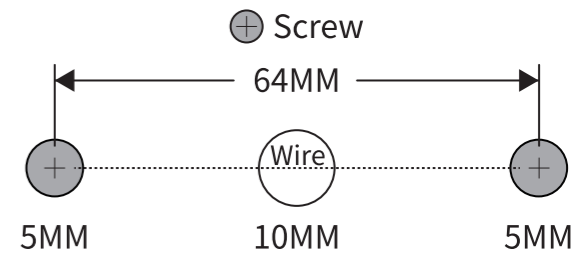

Follow the drawing to drill the hole

COMPONENT

