

# BLUETTI B300S

User Manual

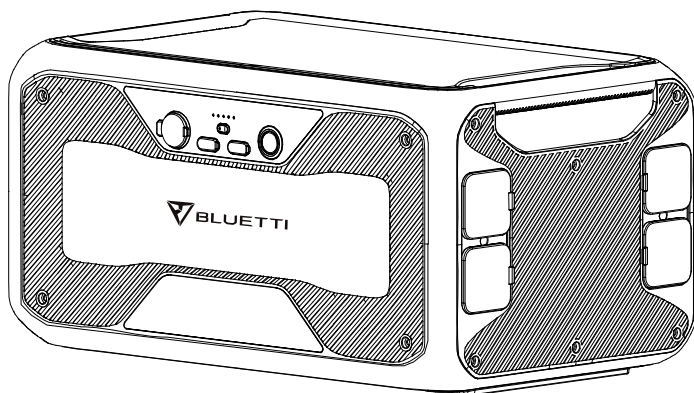

# Thank You

Thank you for making BLUETTI a part of your family.

From the very beginning, BLUETTI has tried to stay true to a sustainable future through green energy storage solutions for both indoor and outdoor use while delivering an exceptional eco-friendly experience for our homes and our world.

That's why BLUETTI makes its presence in 70+ countries and is trusted by millions of customers across the globe.



# CONTENTS

|                                   |           |
|-----------------------------------|-----------|
| <b>Before You Begin</b>           | <b>5</b>  |
| <b>Safety Instructions</b>        | <b>6</b>  |
| General Safety                    | 6         |
| Maintenance                       | 7         |
| Handling & Storage                | 7         |
| <b>What's In The Box</b>          | <b>8</b>  |
| Standard Packaging                | 8         |
| <b>Product Overview</b>           | <b>10</b> |
| Diagram                           | 10        |
| Specifications                    | 11        |
| <b>Operation</b>                  | <b>12</b> |
| Powering On/Off                   | 12        |
| BLUETTI App                       | 12        |
| Charging                          | 13        |
| Capacity Expansion                | 15        |
| <b>Appendix</b>                   | <b>17</b> |
| FAQs (Frequently Asked Questions) | 17        |
| FCC Warning                       | 18        |
| Technical Support                 | 19        |

## Before You Begin

The information contained herein is subject to change without notice.

For the latest version, please visit <https://www.bluettipower.com/pages/user-guides>.

- The user manual contains instructions and notes on the operation and use of this unit.
- BLUETTI recommends that you use genuine accessories from BLUETTI.
- BLUETTI shall not be responsible for any damage or expense that might result from the use of parts other than genuine parts from the BLUETTI.
- For your safety and benefit, please read carefully before using and keep it handy for future reference.

# Safety Instructions

## General Safety

BLUETTI products are developed to be safe and reliable. Please read this guide for important safety information about your device. The guide is intended to help you be more comfortable and productive while using this device. Failure to follow these guidelines for proper set up, use, and care for your device may cause damage to this unit and injury to yourself or others.

### SAVE THESE INSTRUCTIONS!

- Always operate or store the unit in accordance with specified temperature range.
- DO NOT expose the unit to fire, liquids, sweat, dirt or other contaminants, as that may cause the battery to explode or leak flammable liquid or gas.
- DO NOT place the unit on an unstable or tilted surface.
- Make sure the place where you are using the unit is well ventilated and spacious.
- Keep away from children and pets.
- DO NOT modify, attempt to insert foreign objects into the battery, or immerse or expose it to water or other liquids. Batteries may explode if damaged.
- Battery fluid is corrosive and may be toxic. If a battery leaks, keep the leaked fluid from touching your skin, eyes, clothes, or other surfaces. Immediately flush the affected areas with water, or seek medical help.
- DO NOT ignore those warning signs on components or products made by manufacturers.
- DO NOT dismantle, cut, crush, puncture, or otherwise damage the unit in any way.
- DO NOT insert foreign objects into the fan, vents, ports, or other openings.
- NEVER use a damaged battery or component. Improper use or misuse of damaged batteries may cause damage to your device or injury to yourself as a result of battery fluid leakage, fire, overheating, or explosion.

- Use approved battery and accessories ONLY. Improper use, or use of unapproved or incompatible batteries or components may result in a risk of fire, explosion, or other hazards, and may invalidate any approval or warranty.
- Turn off the unit IMMEDIATELY in case of malfunction.
- Use dry powder fire extinguisher in case of fire.
- DO NOT attempt to modify, replace the internal battery or any other component of the unit by anyone other than qualified personnel. If necessary, take it to an authorized service center as incorrect reassembly may result in a risk of fire or electric shock.

### **SAVE THESE INSTRUCTIONS!**

#### **Maintenance**

- When not using the unit for extended periods of time, power off the unit and disconnect the AC adapter from the outlet.
- Charge the unit to 80% SOC every 3-6 months for long-term storage.
- Clean the unit with a dry cloth gently and carefully.

#### **Handling and Storage**

- Use mechanical assistance as needed (e.g. trolleys and adjustable height workbenches).
- DO NOT stack anything on top of the unit either in storage or in use.
- Recommended storage temperature: -4-104°F/-20-40°C.

# What's In The Box

## Standard Packaging

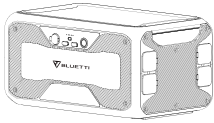

Portable Power Station

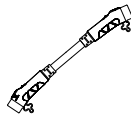

P150D Battery Expansion Cable



DC Input Cable



User Manual



Warranty Card

\* Below accessories are not included in standard packaging and can be purchased separately at <https://www.bluettipower.com/>.



AC Adapter



Car Charging Cable



Lead-acid Battery Charging Cable

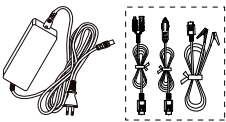

D050S Charging Enhancer Kit

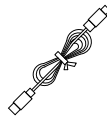

USB-C to USB-C Cable



Cigarette Lighter-F to DC5521 Cable (12V)



AC Adapter (No cable included)  
+ MC4 to DC7909 Cable

\* **P150D Battery Expansion Cable:** 31.5in/80cm.

**DC Input Cable:** 27.6in/70cm. MC4 to XT90.

**AC Adapter:** 118in/300cm.

**Car Charging Cable:** 59in/150cm. Cigarette lighter port to MC4.

**Lead-acid Battery Charging Cable<sup>1</sup>:** 20in/50cm. Clamp to MC4.

**D050S Charging Enhancer Kit:** D050S: 47in/120cm.

**PV Charging Cable:** 27.6in/70cm. MC4 to DC7909

**Car Charging Cable:** 20in/50cm. Cigarette lighter port to DC7909.

**Lead-acid Battery Charging Cable<sup>2</sup>:** 20in/50cm. Clamp to DC7909.

**USB-C to USB-C Cable:** 79in/200cm.

**Cigarette Lighter-F to DC5521 Cable (12V):** 28in/72cm.

**AC Adapter (No cable included) + MC4 to DC7909 Cable:** 47in/120cm; 5.5in/14cm.

**Note:** All measurements are for reference only.

Package details are subject to change without prior notice.

<sup>1</sup> Works with D050S DC charging enhancer and connects to the adapter input port.

<sup>2</sup> Connects B300S directly with the lead-acid battery.



# Product Overview

## Diagram

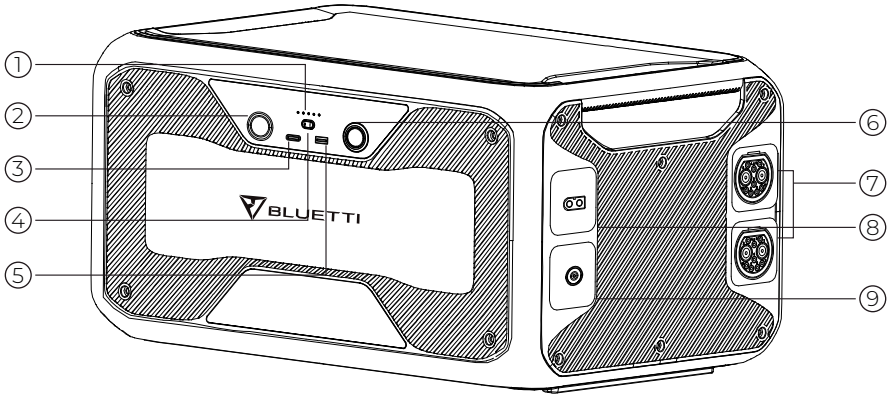

1. Power Indicator\*

2. Cigarette Lighter Port

3. USB-C PD3.0

4. DC Power Button

5. 18W USB-A Port

6. Power Button

7. Battery Expansion Port

8. PV Input

9. Adapter Input

\* These lights represent the power level, one light for 20%. When it drops to 20%, please recharge the B300S for extended lifespan.

## Specifications

| B300S  |                                |  |
|--|--------------------------------|--|
| General  |                                |  |
| Capacity   | 3072Wh                         |  |
| Voltage  | 51.2VDC                        |  |
| Cell Type  | LiFePO4                        |  |
| Dimensions (L*W*H)   | 20.5*12.6*10.4IN/520*320*263MM |  |
| Weight   | 83.8LB/38KG                    |  |
| Discharging Temperature  | -4-104°F/-20-40°C              |  |
| Charging Temperature   | 32-104°F/0-40°C                |  |
| Storage Temperature  | -4-104°F/-20-40°C              |  |
| Working Humidity   | 10-90%                         |  |
| DC Output  |                                |  |
| Cigarette Lighter Port *1  | Voltage                        | 12VDC                                      |
|  | Current                        | 10A  |
| USB-A QC3.0 *1   | Power                          | 18W Max. (3.6-12VDC, 3A)                   |
| USB-C PD3.0 *1   | Power                          | 100W Max. (5/9/12/15/20VDC, 3A; 20VDC, 5A) |
| Adapter Input  |                                |  |
| Power  | 500W Max.                      |  |
| Voltage  | 58.8VDC                        |  |
| Current  | 8A Max.                        |  |
| PV Input   |                                |  |
| Power  | 500W Max.                      |  |
| Voltage  | 12-60VDC                       |  |
| Current  | 10A Max.                       |  |
| Car Charging   |                                |  |
| Power  | 196.8W Max.                    |  |
| Voltage  | 12/24VDC                       |  |
| Current  | 8.2A Max.                      |  |
| Capacity Expansion   |                                |  |
| Voltage  | 51.2VDC                        |  |
| Current  | 120A                           |  |
| <p><b>Note:</b> When connecting B300S with the T500 adapter or AC500 to the grid, B300S is able to self-heat and get charged even at -4°F/-20°C.</p> |                                |  |

# Operation

## Powering On/Off

**Startup/Shutdown:** Press the power button to start up or shut down this unit.

| Operation | Green light(on the button) | Power Indicator Light |
|-----------|----------------------------|-----------------------|
| Startup   | ON                         | ON                    |
| Shutdown  | OFF                        | OFF                   |

**DC Output:** Press the DC power button to start up or shut down.

**Note:** Unplug to turn off the unit. Connect to the power source and it turns on automatically.

## BLUETTI APP

Download the BLUETTI App from Google Play or App Store.

The remaining battery capacity can be viewed from the App when connected with AC500.

The firmware can also be over-the-air (OTA) upgraded. For more details, please refer to the BLUETTI App.

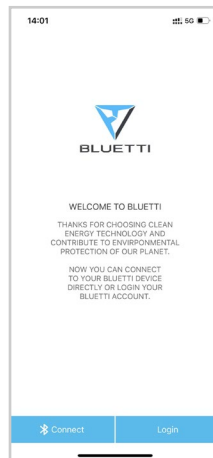

**Note:** Keep your phone no more than 5m/16.4ft away from the unit during the update.

## Charging

### AC Charging

Simply plug the B300S into a standard wall outlet and start charging.

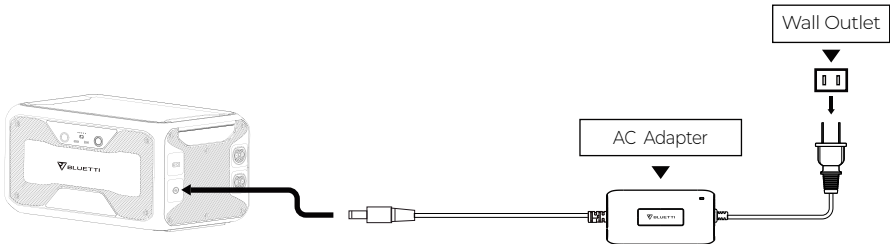

### PV Charging

Connect the solar panels (in series or parallel) to B300S with the DC input cable.

**Note:** Please make sure your solar panels comply with:

OCV<sup>3</sup>: 12-60V    Vmp<sup>4</sup>: 12-60V    Input Power: 500W Max

**Eg:** Connect two BLUETTI PV200 solar panels in series to charge the unit.

BLUETTI PV200: Voc=26.1V    Vmp=20.5V    Current=9.7A Max.

Total: Voc=26.1×2=52.2V    Vmp=20.5×2=41V    Current=9.7A Max.

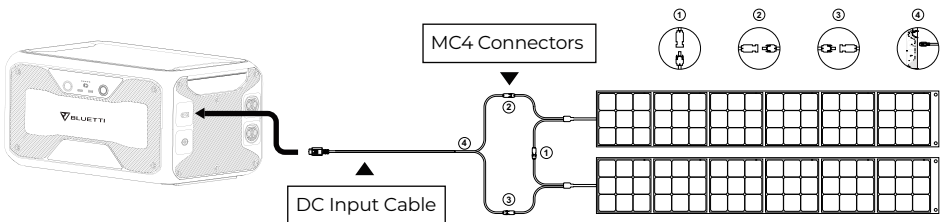

<sup>3</sup>OCV: Open circuit voltage, also for Voc. The maximum voltage that the solar panel can produce with no load on it.

<sup>4</sup>Vmp: Voltage at maximum power. The voltage available when the panel is operating at its peak performance output.

## Car Charging

Connect the B300S to the vehicle plug-in cigarette lighter port via the DC input cable and car charging cable.

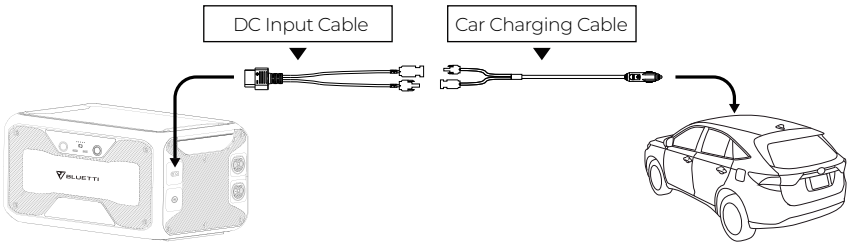

## Dual Charging

The B300S also supports charging from adapter and solar panels at the same time.

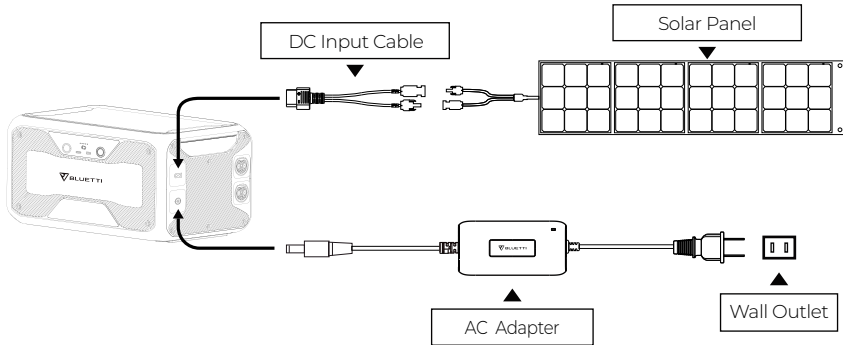

## Capacity Expansion

Connect the B300S with BLUETTI AC500 power station by P150D battery expansion cable.

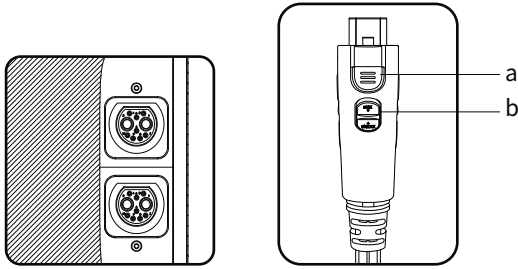

(P150D Battery Expansion Cable)

- a: Enable/disable the battery expansion function.
- b: Lock/unlock the connection.

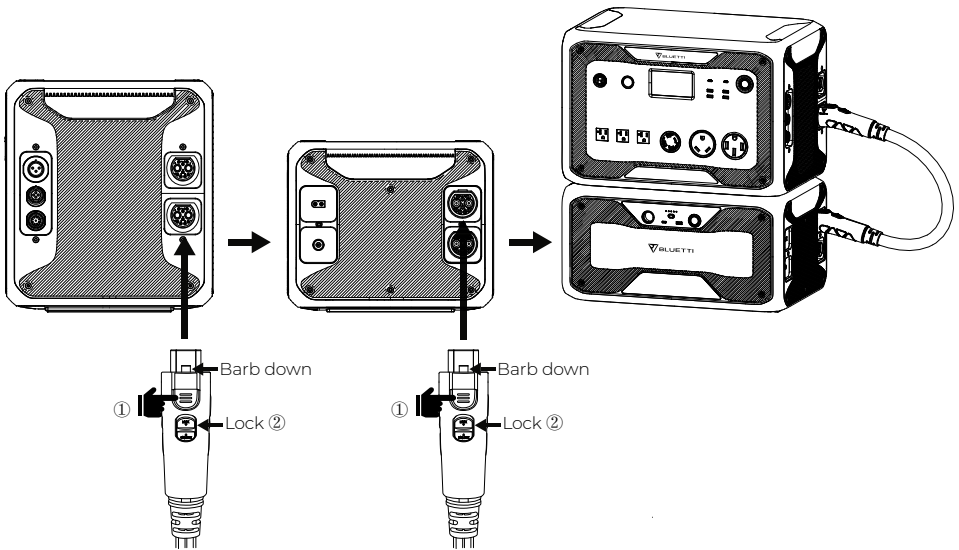

AC500 + 1\*B300S = 4500W Max. / 3072Wh

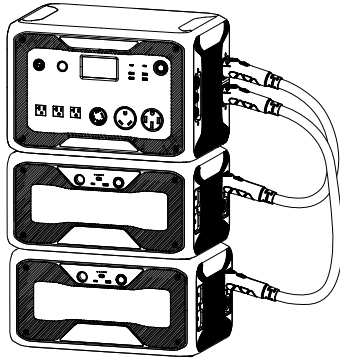

AC500 + 2\*B300S = 5000W Max. / 6144Wh

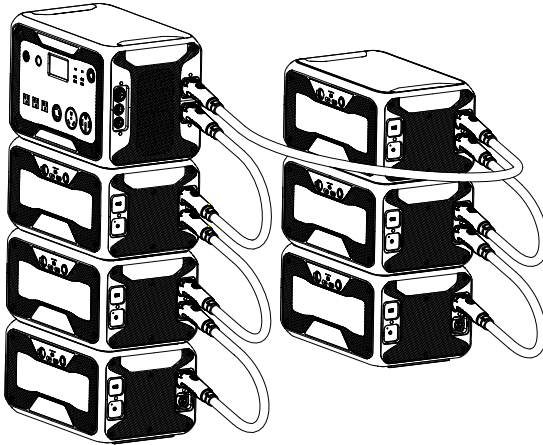

AC500 + 6\*B300S = 5000W Max. / 18432Wh

### B300S Capacity Expansion Tutorial

**Note:** Press the power button either on AC500 or B300S to turn on the AC500 + B300S combo.

When AC500 is connected to the grid or solar panels, the combo turns on automatically.

If there's only one B300S connected, the combo delivers a maximum output of 4500W.

To get 5000W AC output, connect at least one expansion battery to each expansion port.

# Appendix

## FAQs (Frequently Asked Questions)

**Q: Can it charge and discharge at the same time?**

A: Yes. It supports pass-through charging. B300S comes with the premium LiFePO4 battery and proprietary Battery Management System(BMS) to ensure that it can charge and discharge at the same time.

**Q: Can I use third-party solar panels to charge this unit?**

A: Yes, you can. As long as the specs of solar panels you're using fall in below range:

OCV: 12-60V

Vmp: 12-60V

Input Power: 500W Max.

With the same power connector (MC4)

DO NOT mix different types of solar panels.

**Q: How to upgrade the firmware of B300S?**

A: Connect it to the AC500 or other compatible power station, pair the system with BLUETTI App, and you can over-the-air (OTA) upgrade the firmware including ARM, DSP, HMI, and BMS.

**Q: How to store B300S expansion battery for a long time?**

A: Charge it to 80% SOC every 3-6 months for long-term storage.



## FCC Warning

This device complies with part 15 of the FCC Rules.

Operation is subject to the following two conditions:

- 1) This device may not cause harmful interference
- 2) This device must accept any interference received, including interference that may cause undesired operation.

This equipment has been tested and found to comply with the limits for a Class B digital device, pursuant to part 15 of the FCC Rules. These limits are designed to provide reasonable protection against harmful interference in a residential installation. This equipment generates, uses and can radiate radio frequency energy and, if not installed and used in accordance with the instructions, may cause harmful interference to radio communications. However, there is no guarantee that interference will not occur in a particular installation.

If this equipment does cause harmful interference to radio or television reception, which can be determined by turning the equipment off and on, the user is encouraged to try to correct the interference by one or more of the following measures:

- 1) Reorient or relocate the receiving antenna.
- 2) Increase the separation between the equipment and receiver.
- 3) Connect the equipment into an outlet on a circuit different from that to which the receiver is connected.
- 4) Consult the dealer or an experienced radio/TV technician for help.

### **FCC RF Radiation Exposure Statement**

This equipment complies with FCC radiation exposure limits set forth for an uncontrolled environment. This equipment should be installed and operated with minimum distance 20cm between the radiator and your body. This transmitter must not be co-located or operating in conjunction with any other antenna or transmitter.

**FCC Caution:** Any changes or modifications not expressly approved by the party responsible for compliance could void the user's authority to operate this equipment.

## Technical Support

Should you require any further assistance, please do not hesitate to contact BLUETTI service team.

### BLUETTI POWER INC

Web: <https://www.bluettipower.com/>

Tel: 833-988-3663 / 702-463-4792

Mail: [service@bluettipower.com](mailto:service@bluettipower.com)

Add: 6185 S Valley View Blvd Ste D. Las Vegas, NV 89118.



