

User Manual

Magnetic Lock 280KG

Please read this manual carefully before installation.

Introduction

We supply all kinds of magnetic lock with the holding force 60KG, 180KG, 280KG, 350KG, 500KG. They can be installed for glass door, wooden door, fireproof door, sliding door and metal door. High-strength aluminum alloy and anti-residual magnetism design makes the access control system safer and durable.

Product Parameter

Holding Force	280KG (600LBs)
Power Input	DC12V/400mA, DC24V/200mA
Surface Temp	≤ +20°C
Operating Tem	-20°C ~ +55°C (-4-131°F)
Suitable	Glass door, wooden door, fireproof door, sliding door, metal door
Weight	2.2KG

Instructure Diagram

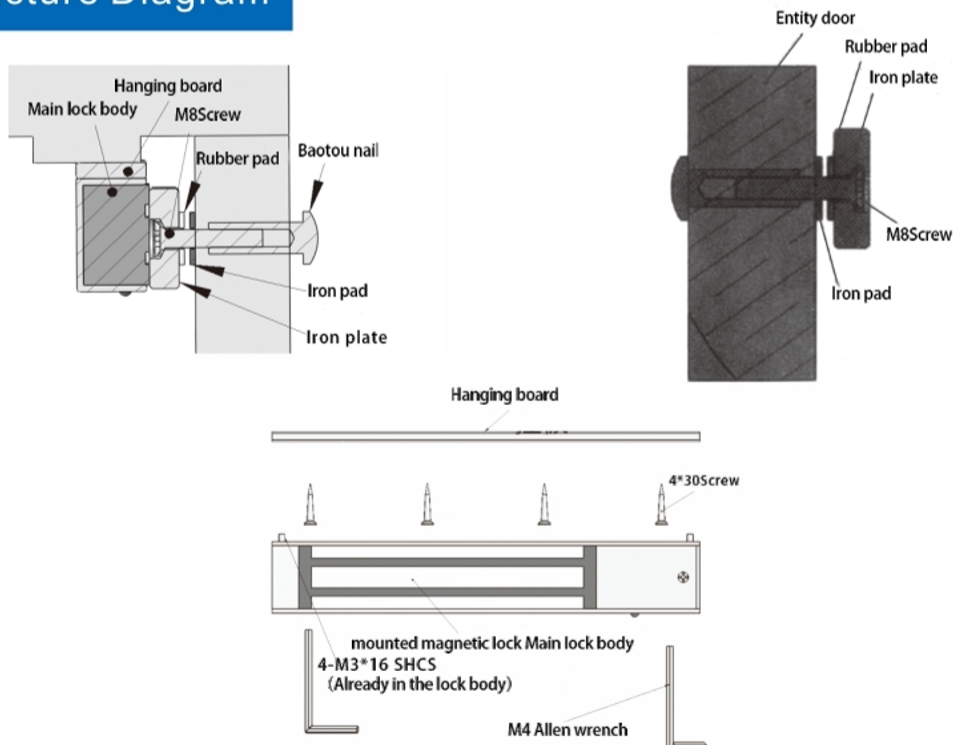

Mortise Installation Diagram

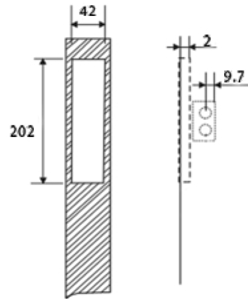

Embedded size

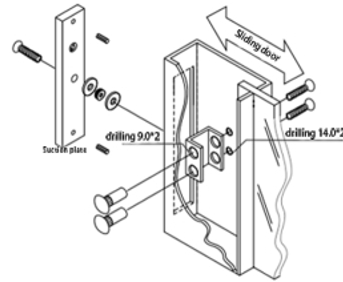

Fixed size

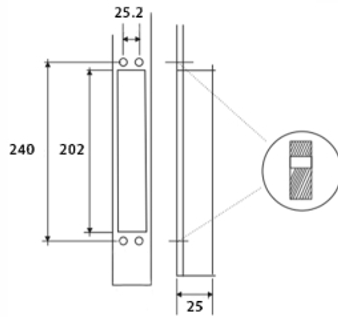

Embedded size

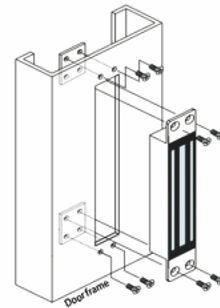

Fixed size

Optional Bracket

Different auxiliary brackets are used according to different types of door frames. For example, doors with narrow door frames, frameless glass doors, inward opening doors, etc.

L-shaped auxiliary bracket

When the door frame width is lower than 42MM, if there is not enough width to install the magnetic lock suction plate, an L-shaped bracket is required.

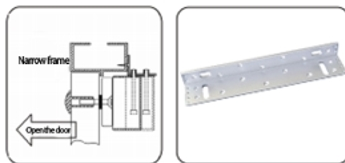

ZL auxiliary bracket

If the inner opening type door is installed in the door, the ZL type auxiliary bracket is required.

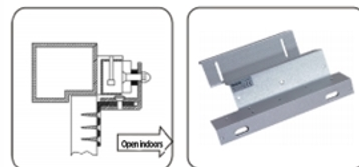

U-shaped auxiliary bracket

If the door is a glass door, a U-shaped auxiliary bracket (for 10-15mm glass door) is required.

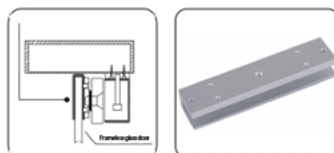

Suction plate mounting bracket

If the door leaf is too thick, the suction plate needs to be equipped with a tray

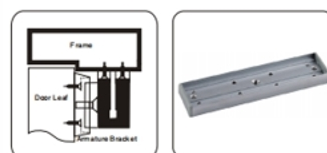

Armature Plate Instalation

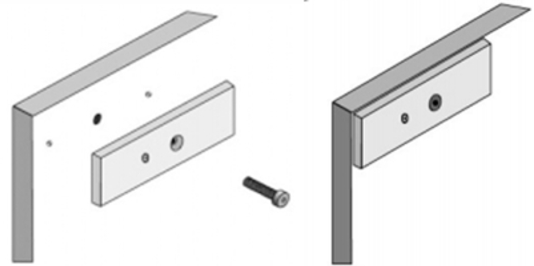
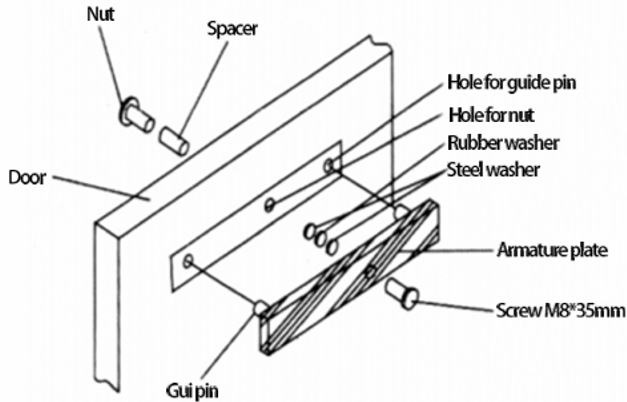

Note: Do not screw the iron plate too tightly, and leave the rubber washer elastic, so that the suction plate can be automatically adjusted to match the magnetic lock..

Wiring Diagram

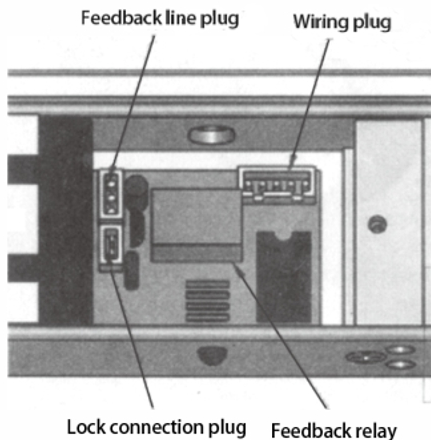

V+ Red line: positive electrode power supply
 V- black line : negative electrode power supply
 NO Yellow line: always open
 COM Green line: open end
 NC White line: normally closed

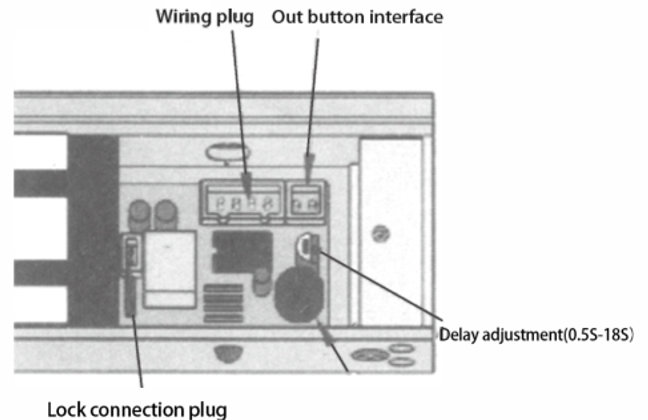

V+ Red line: positive electrode power supply
 V- black line : negative electrode power supply
 IN+ blue line: unlock positive
 IN- White line: unlock the negative pole

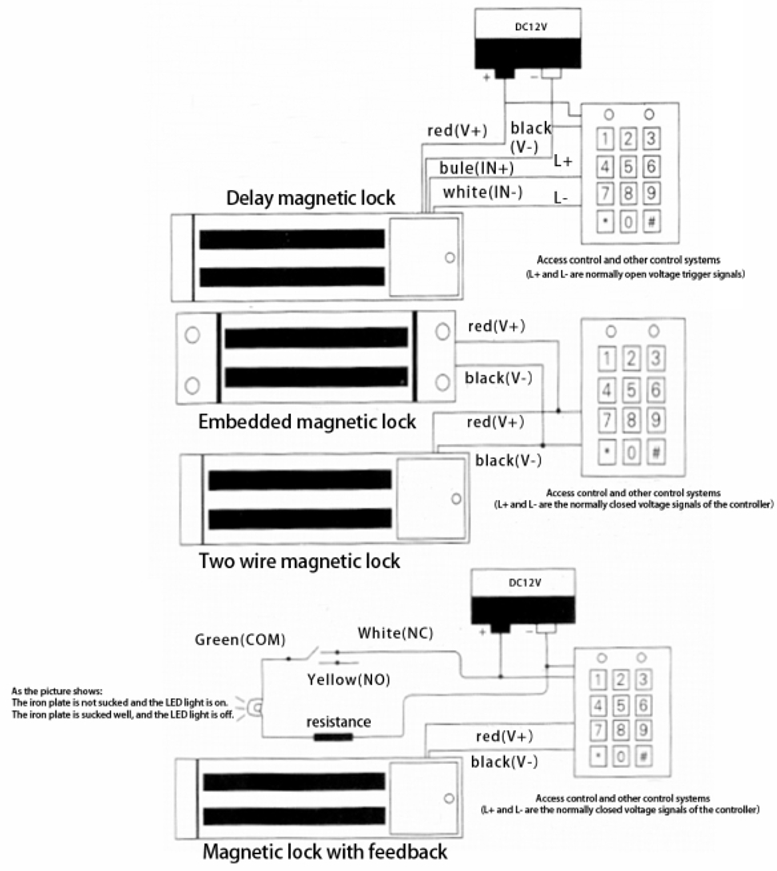

Common Installation Method

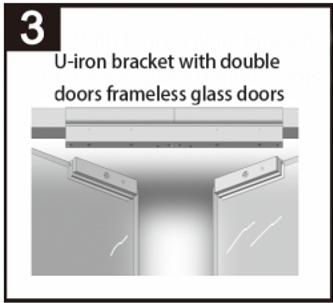
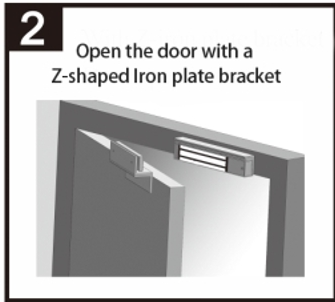

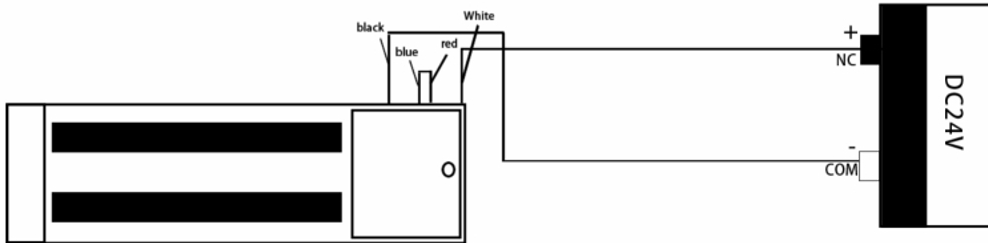
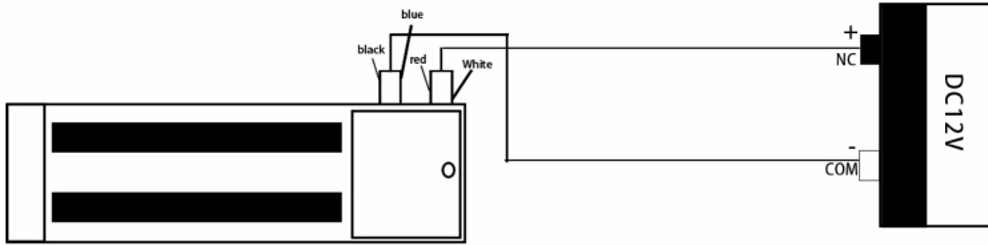

Ordinary 4-wire magnetic lock

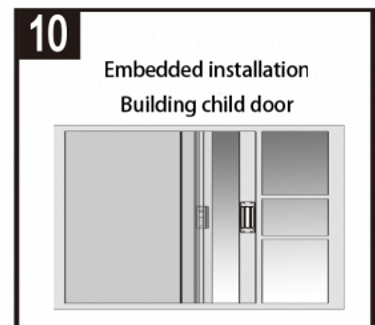
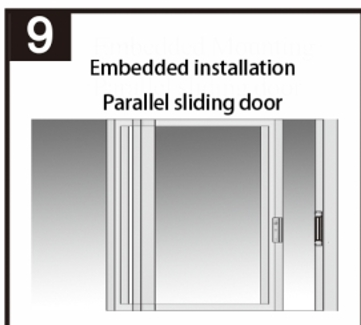
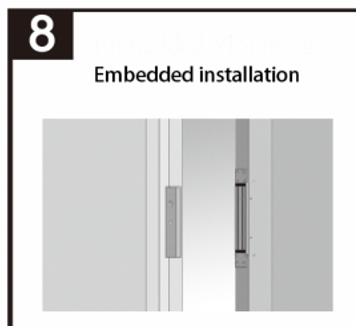

Troubleshooting

A. After power-on, the indicator light is not lit.

1> If the "Power Selection" of the board is set to 12V; please check if the power supply has DC12V, current above 330~500mA.

2> If the "Power Selection" of the board is set to 24V; please check if the power supply has DC24V, current above 420~500mA.

B. After transmission, the light did not shine, but it will not attract iron lock.

1> If the power is insufficient, check if the power is sufficient.

2> The electromagnetic lock and the iron block may not be tightly combined. Please adjust the angle and position.

3> may be poor quality transformer, causing interference, replace the line with the specifications of the power supply.

C. After power indicator light, lock suck iron, but the lack of suction.

1> There may be insufficient electromagnetic lock and iron block. Please check if there is any dust, iron filings and other miscellaneous stains in the middle.

2> may be the electromagnetic lock is not properly aligned with the iron, only a portion of the adsorbed iron, please adjust the position.

3> may be insufficient voltage or Jumper jump wrong, please check.

D. After transmission, the lock take some time to suck (applicable to each series-type magnetic locks)

1> may delay timer knob to adjust too long, counterclockwise recall.

2> It may be too long for the external controller, please adjust.