



ANVIZ®



2022

# Access Control & Time and Attendance Solutions

# Contents

## **About Anviz**

Leading Security Solution Provider for Commercial Market

## **Face Recognition**

AI Based Smart Face Recognition Terminals

## **Outdoor Access**

Outdoor Biometric & RFID Access Control

## **CrossChex**

Access Control & Cloud-based Time and Attendance Software

## **Mobile Access**

Secure & Convenient Touchless Access Control

## **Time and Attendance**

Biometric-based Time Attendance Management

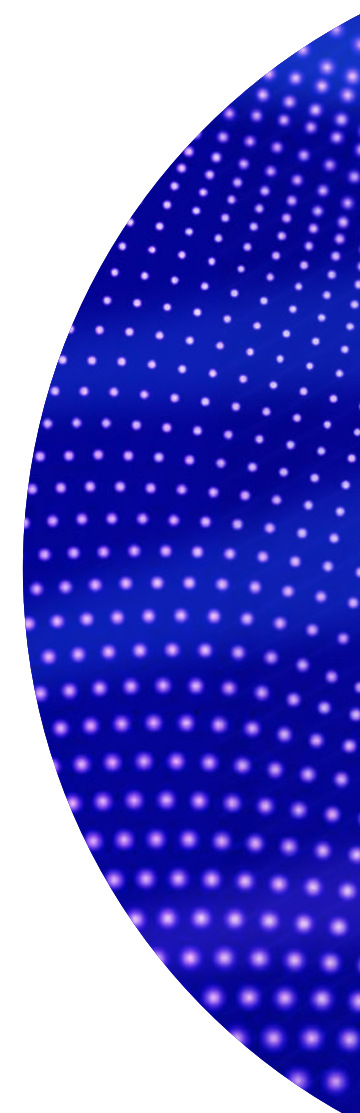



# About Anviz

Providing smart solutions based on cloud and IoT technologies to SMB and enterprises clients globally.

**20 Years +**  
Experiences

**100+**  
Countries

**200,000+**  
Projects

**200+**  
Intellectual Property

**BioNANO**  
Core Algorithm

**RVI™**  
Video Intelligence Analysis

**Cloud**  
Anviz Open Cloud Platform

**ACP™**  
Anviz Secure Control Protocol



## China Office

Global R&D Center & Operation Center





**Access Control & Time and Attendance Solutions**



**Intelligent Surveillance Products and Solutions**

**USA Office**

Sales & Operation & Customer Service Center



**Manufacturing Base**

50,000 Square Meters  
2,000,000 Units Capacity Annually

**2019**

Secu365 business unit established



**2017**

Successful on commercial market



**2015**

U-TEC business unit established



**2011**

AGPP global partnership program launched



**2005**

Anviz Global established



# Anviz Milestones



**2020**

AI facial recognition



**2018**

Open new production base



**2016**

Smart lock product line landed on north america market



**2013**

Start full HD product line



**2007**

Launched first generation access control and time attendance product

## Technical Partner



# Anviz Core Technologies

Anviz values innovation, we invest most of our funds in the R&D department to stay at the top of the biometric access control, time and attendance, and surveillance industry. Anviz recruits professional developers around the world, and technical teams located in global offices to support our clients timely.

## **BioNANO®** Patent Biometrics Algorithm



### Fingerprint Algorithm

- Auto Adjust for Wet and Dry Finger
- FFD (World Best Fake Finger Detection)
- Securer Fingerprint Template Encryption
- Heal Broken Fingerprint Line



### Face Algorithm

- Liveness Face Detection
- Global Face Detection Adoption
- Masked Face Detection
- Fast Forehead Positioning and Temperature Detection



### Iris Algorithm

- Most Securer Comparison Way
- 1:1,000,000 Lowest False Rate
- Adopt for Complex Environment
- Two Eyes Accurate Identification



## Patent Surveillance Realtime Video

### Smart Imaging

- True WDR Technologies
- Startlight Imaging Priority
- Smart IR Technology
- Image Distortion Correction

### AI Algorithms

- Person Detection
- Vehicles Detection
- Intruder Detection
- Crossline Detection



# ance Algorithm o Intelligence



## Data Privacy & Security

### Smart Stream and Storage

- Auto Optimize Stream in Damic Area
- Auto Optimize Stream for ROI Area
- Three streams for Smart Usage
- Multiple Storage Options

### Data Security

- End to End Data Encryption
- AWS Global Cloud Platform
- Login Verification
- AES256 & HTTPS Protection

### Biometric Template Encryption

We use our own algorithm to encrypt the data into codes and we never restore any raw fingerprint, face or Iris image.

### Personal Information on Card

We provide biometric information on card technologies, to restore the fingerprint, face templates on Mifare card and not restored in device, so ensure the privacy to use these biometrics information.

### Personal Information on Mobile

We provide biometric information on mobile technologies, to restore the fingerprint, face templates on mobile phone and not restored in device, so ensure the privacy to use these biometrics information.

### End to End Data Protection

All the data communication among edge device, local server, cloud server and APP are projected and encrypted by AES256 and HTTPS protocol to ensure the overall protection to follow the GDPR regulations.

# Why Anviz?

## Global Sales

**4**

Global Offices

**300+**

Employees

**100+**

Distributors

**30+**

Technical Partners

**2000+**

Resellers

**50+**

System Integrators

Canada

USA

South  
America

Europe

Shanghai

South  
East Asia

Africa

## Project Registration Program

Anviz rewards you for specifying Anviz products in project bidding. We give our integrator partners the opportunity to strengthen their position on projects with special pricing and the full and active support of the Anviz team.

# Success Stories



Mexico Government Liveness Fingerprint Access Control Project

**100,000** staffs

**1,000** sites



Top 20 Universities Cloud-based Time & Attendance Project

**150,000** students and faculties



Total Security Solution for Global offices of A Corporate

**50,000** staffs across more than **30** global branches

# Global Events



Global Expo



Road Show



Training Webinar

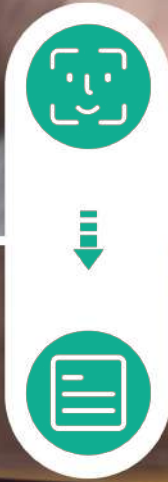

# CrossChex

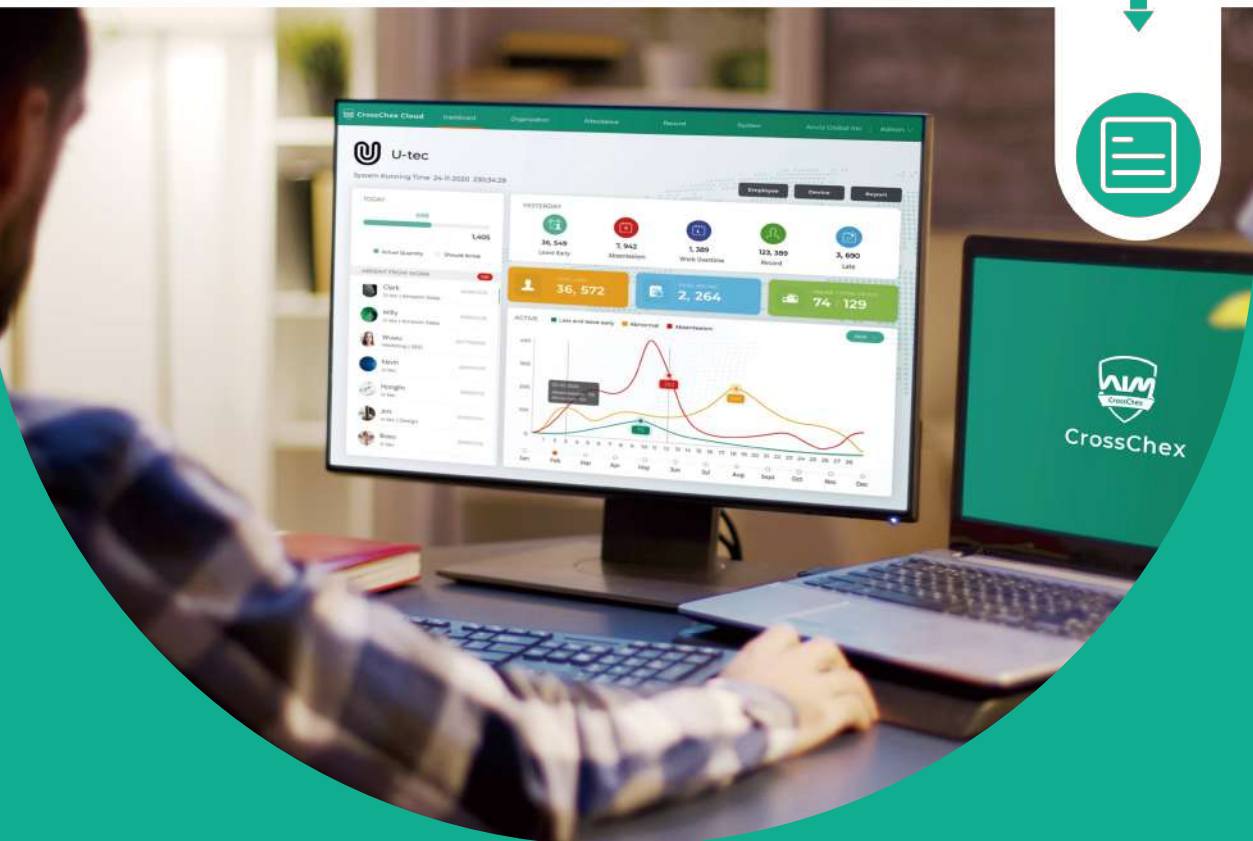

## CrossChex Standard

Desktop Access Control & Time Attendance Software

CrossChex is a professional access control and time & attendance management solutions. With it's unique features and flexible and multiple system deployment structures, customer oriented concepts to satisfy SMB and enterprises clients for their time management, access control management requirements and help them improve the overall efficiency on HR and security management.

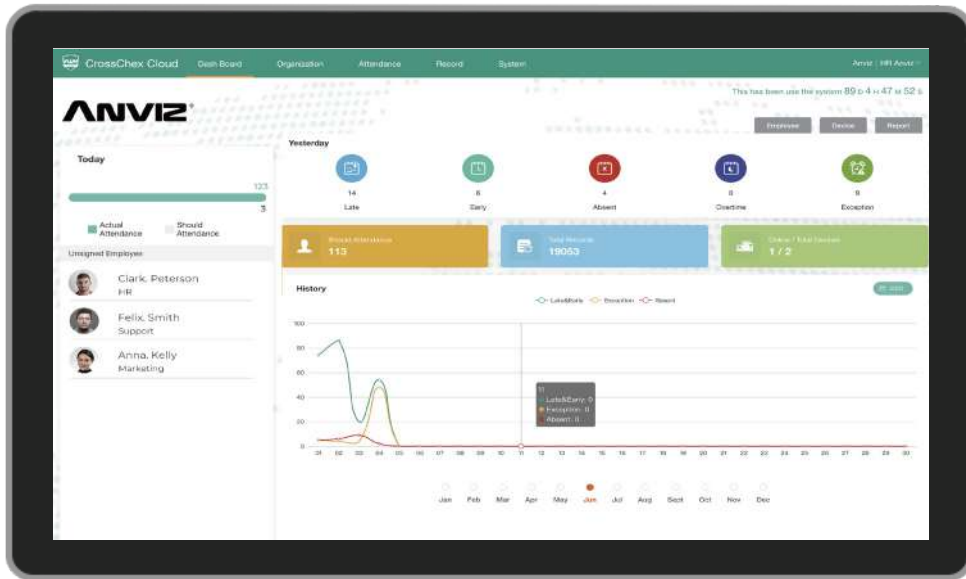

- Manage your time and attendance on cloud without any software.
- Access data anywhere, anytime, from any computer.
- Track employees from any location to see where employees clocked in and out.
- View reports of employees' attendance and health.
- Shift work times whenever you want.

 **High-Impact Reporting**  
Easily track and export employee hours in seconds which makes you feel intuitive with daily processes.

 **Powerful Dashboard**  
The handy dashboard lets you easy to track employee attendance by real-time analytics.

 **Best-in-Class Scheduling**  
Easily set up attendance rules, create and manage employee schedules for all your organization.

 **Super Easy Employees and Devices Management**  
Easy and quick to set up devices and add, delete, or modify employees' information.

# CrossChex Cloud

## Cloud-based Time & Attendance Management Solution

CrossChex Cloud is a super quick setup and easy to use system dedicated to saving your business money through employee time management works for any business.



Scheduling

Dashboard

Reporting

Management

Mobile

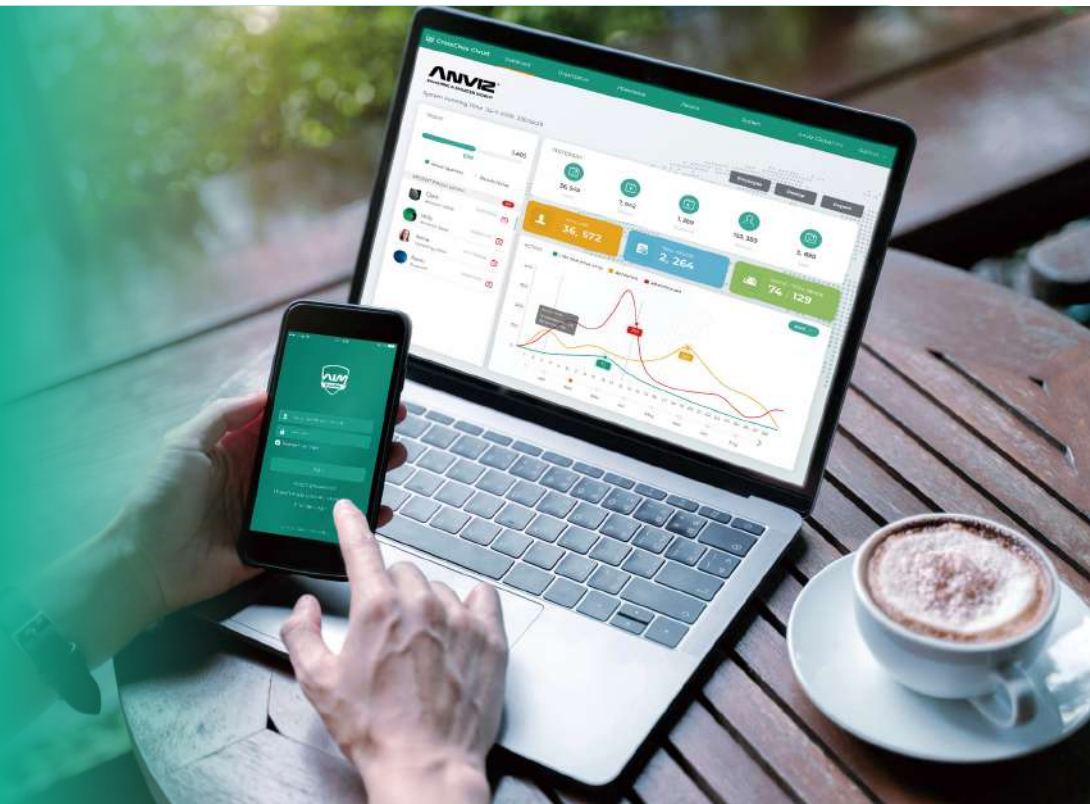



CrossChex





# CrossChex Mobile

## More Convenient More Secure

CrossChex Mobile is the mobile version of CrossChex Software, which lets you add and manage everyone and grant access rights to them on a smartphone. Your staff can easily clock in and access to any places with just one click on the phone. Any of Anviz access control devices with Bluetooth function can be added to CrossChex Mobile, and the time attendance device with Bluetooth function can be also added to CrossChex Mobile to have a clock in function and realize the access control function with linked to a Bluetooth micro access controller. CrossChex Mobile is suitable for the application in small offices, retail stores, gyms, clinics, etc.



## For Users

- Use your phone to unlock doors.
- Employees can check in and out from the phone.
- No more lost, misplaced or shared cards.
- Check attendance record from your phone.



## For Admins

- Use your phone to add and delete users/ fingers/ cards.
- Grant or revoke access to anyone with one click.
- Save cost of issuing cards and maintenance in comparison to physical cards.

# Face Recognition

Today's dynamic business environment requires real-time time management and access control solution with anytime, anywhere access. Anviz's FaceDeep Series, a fully integrated contactless and thermal management face recognition solution for the people to access control of entrances or record attendance time and simultaneously check temperature and mask-wearing without having to touch a terminal or gate, requirements which are quickly finding their way into commercial offices, hospitality and retail chains, hopeful crowded sports arenas, medical facilities, and more.



-   
**AI**  
 AI Deep Learning Engine
-   
**Various Conditions**
-   
**3D Live Face Detection**
-   
**Support Cloud**
-   
**Temperature Screening**

## Mounts



### Auto Swing Door

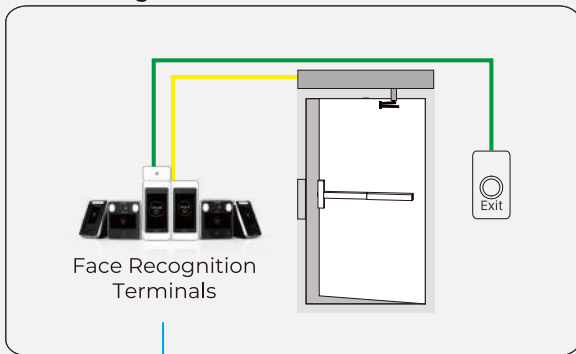

### Auto Sliding Door

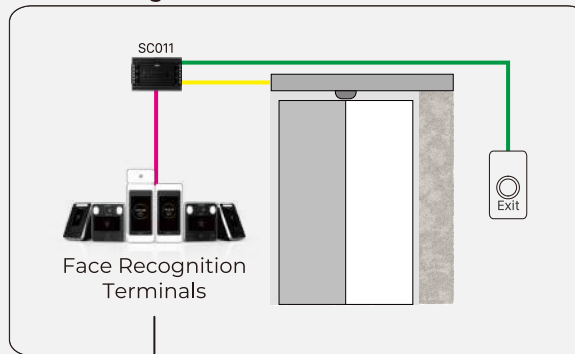

### Time Clocking Point

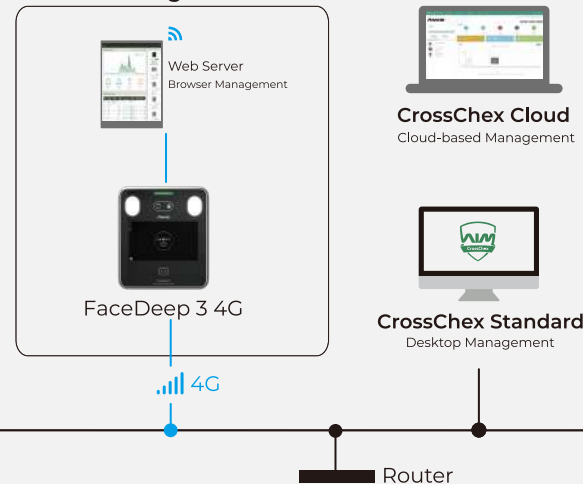

- Exit Button
- Anviz Wiegand
- Relay





FaceDeep 3 &  
FaceDeep 3 IRT



FacePass 7 Pro &  
FacePass 7 Pro IRT







FaceDeep 5 &  
FaceDeep 5 IRT



FaceDeep 3 QR &  
FaceDeep 3 IRT QR

# Specification Comparison

				
Product				
Product Name	W3	FacePass 7 Pro	FaceDeep 5	
Hardware Function	Face Templates Capacity	200	3,000	20,000(Standard), 50,000(Customized)
	Log Capacity	50K	100K	100K
	LCD	2.8" TFT	3.5" TFT Touchscreen	5.0 TFT Touchscreen
	Verify Speed (1:3000)	<1.0s	<0.3s	<0.2s
	Live / Fake Detection	✓	✓	✓
	Mask Detection	✓	✓	✓
	Identify Distance	0.3~1.0m (0.39~0.79')	0.3~1.3m (1.181~51.18")	0.3~2.0m (11.81~19.69")
	Temperature Detection	-	<b>FacePass 7 Pro IRT:</b> Body Temperature Detection	<b>FaceDeep 5 IRT:</b> Body Temperature Detection
	Body Temperature Detection Distance	-	30~50cm (11.81~0.79')	30~50cm (11.81~0.79')
	RFID Options	125kHz EM	<b>FacePass 7 Pro:</b> 125kHz EM <b>FacePass 7 Pro IRT:</b> 125kHz EM <b>FacePass 7 Pro-MIF:</b> 13.56MHz MIFARE <b>FacePass 7 Pro IRT-MIF:</b> 13.56MHz MIFARE	125kHz EM & 13.56MHz MIFARE
	QR Code Scanning Distance	-	-	-
	Batch Enrollment	-	✓	✓
Communication	TCP/IP	✓	✓	✓
	Wi-Fi	Optional	✓	✓
	RS485	-	✓	-
	Bluetooth	-	-	-
	USB Host	-	✓	✓
Access Control Interface	Internal Relay (Door Control)	✓	✓	✓
	Exit Button	✓	✓	✓
	Door Contact	✓	✓	✓
	Wiegand Output	-	✓	✓
	Wiegand Input	✓	✓	✓
	Tamper Switch	✓	✓	✓
	Environments	Indoor	Indoor	IP65 / Outdoor
	Software	CrossChex Standard & CrossChex Cloud	CrossChex Standard & CrossChex Cloud	CrossChex Standard & CrossChex Cloud

			
FaceDeep 3	FaceDeep 3 Pro	FaceDeep 3 4G	FaceDeep 3 QR
6,000	6,000(Standard), 10,000(Customized)	6,000(Standard), 10,000(Customized)	6,000
100K	100K	100K	100K
5.0 TFT Touchscreen	5.0 TFT Touchscreen	5.0 TFT Touchscreen	5.0 TFT Touchscreen
<0.3s	<0.3s	<0.3s	<0.3s
✓	✓	✓	✓
✓	✓	✓	✓
0.3~1.5m (11.81~59.06")	0.3~1.5m (11.81~59.06")	0.3~1.5m (11.81~59.06")	0.3~1.5m (11.81~59.06")
<b>FaceDeep 3 IRT: Body Temperature Detection</b>	<b>FaceDeep 3 Pro IRT: Body Temperature Detection</b>	<b>FaceDeep 3 4G IRT: Body Temperature Detection</b>	<b>FaceDeep 3 IRT QR: Body Temperature Detection</b>
1~2cm (0.39~0.79")	1~2cm (0.39~0.79")	1~2cm (0.39~0.79")	1~2cm (0.39~0.79")
125kHz EM	13.56MHz MIFARE	13.56MHz MIFARE	-
-	-	-	3~10cm (1.18~3.94")
✓	✓	✓	✓
✓	✓	✓	✓
✓	✓	✓	✓
✓	✓	✓	✓
-	✓	✓	-
✓	✓	✓	✓
✓	✓	✓	✓
✓	✓	✓	✓
✓	✓	✓	✓
-	✓	✓	-
✓	✓	✓	✓
Indoor	Indoor	Indoor	Indoor
CrossChex Standard & CrossChex Cloud	CrossChex Standard & CrossChex Cloud	CrossChex Standard & CrossChex Cloud	CrossChex Standard & CrossChex Cloud

\*Power Input: DC12V

# Access Control

## Outdoor Access

M Series standalone access control devices is suitable for various outdoor environment, with its professional IP65 and IK10 design. M series is integrated with fingerprint and keypad touchable and RFID card, NFC and optional Bluetooth touchless identification ways. M series can be applied into direct and distributed door controlling, wiegand output to third party controller, and also can be integrated with turnstiles, outdoor consumer terminals, etc.



### Metal Housing IK10 Vandal-proof Structure

Come with robust, vandal-resistant metal housing and sophisticated engineering, it's able to withstand a high level of impact, making it vandal-resistant.



### IP65 Dust & Water Proof

Anviz M Series is a perfect solution for outdoor applications coupled with IP65 ingress protection.



### Versatile Access Control Interfaces

M Series comes with full TCP/IP, RS-485 and Wiegand interfaces to provide higher flexibility and multiple installation options for different environments. It offers an exit button and door sensor inputs and 1 relay output to control peripheral devices



### Mobile Access

Easily access any place with just one click on the phone.

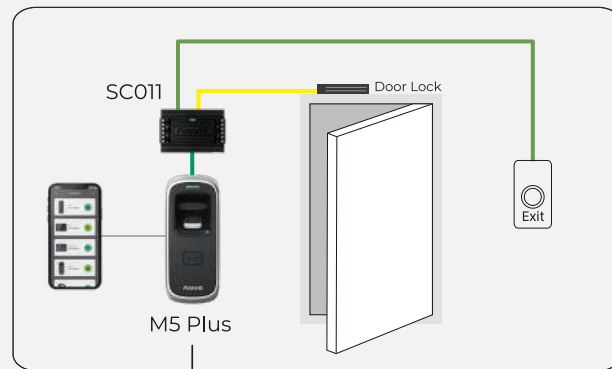

TCP/IP

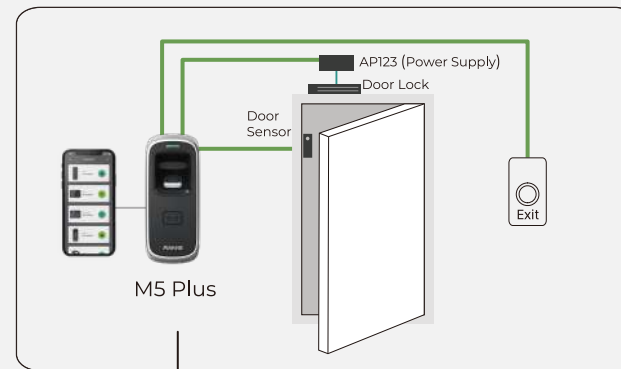

TCP/IP

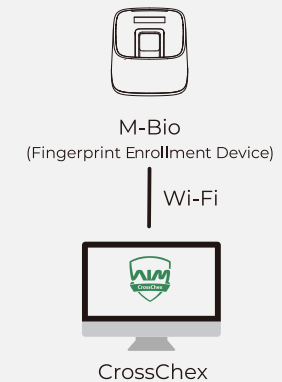

— Output — Input — Relay

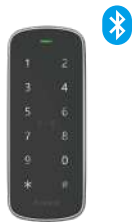

M3 Pro

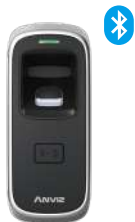

M5 Plus



M7



M8

# Specification Comparison

	Product		
General	Product Name	M3 Pro	M5 Plus
	Identification Mode	Password, Card	Finger, Card
	RFID Options	125KHz EM & 13.56MHz MIFARE	125KHz EM(Standard), 13.56MHz MIFARE(Optional)
Capacity	Max. Users	10,000	3,000
	Max. Cards	10,000	3,000
	Max. Logs	100,000	50,000
Function	Group, Time Zone	16 groups, 32 time zones	16 groups, 32 time zones
	Web Server	√	√
	Voice Prompt	Buzzer	Buzzer
	Multiple Language	-	-
Hardware	Software	CrossChex Standard	CrossChex Standard
	CPU	Linux 1.0 GHz	Linux 1.0 GHz
	Sensor	-	AFOS Touch Active Sensor
	Scanning Area	-	22mmx18mm (0.87x0.71")
	Display	-	-
	Keypad	Touch Active	-
	Dimensions(W x H x D)	124x47x22mm (4.88x1.85x0.87")	50x124x34.5mm (1.97x4.88x1.36")
	Working Temperature	-30°C~60°C (-22°F~140°F)	-30°C~60°C (-22°F~140°F)
	Humidity	20% to 90%	20% to 90%
	PoE	-	-
	Power Input	DC12V	DC12V
	Protection Class	IP65, IK10	IP65, IK10
	I/O	TCP/IP	√
RS485		√	√
Wi-Fi		√	√
Bluetooth		√	√
Relay		√	√
I/O		Door Contact/ Exit Button	Door Contact/ Exit Button
Tamper Alarm		√	√
Anti-pass Back		-	√
Wiegand	Output	Output	



M7

Finger, Password, Card

125KHz EM & 13.56MHz MIFARE

3,000

3,000

50,000

16 groups, 32 time zones

-

Buzzer

✓

CrossChex Standard

32-bit Processor

AFOS Touch Active Sensor

22mmx18mm (0.87x0.71")

1.28 OLED Screen

Physical Button

58x166x32mm (2.28x6.54x1.26")

-30°C~-60°C (-22°F~140°F)

20% to 90%

IEEE802.3af/at

DC12V

IP65, IK10

✓

✓

-

-

✓

Door Contact/ Exit Button

✓

-

Output



\*



M8

Face, Password, Card

125KHz EM(Standard), 13.56MHz MIFARE(Optional)

1,000

1,000

100,000

16 groups, 32 time zones

✓

Voice

✓

CrossChex Standard & CrossChex Cloud

Linux 1.0 GHz

Camera

-

4.3" TFT

Touch Active

124x47x22mm (4.88x1.85x0.87")

-10°C~-60°C (14°F~140°F)

20% to 90%

IEEE802.3af/at

DC12V

IP65

✓

✓

✓

Optional

✓

Door Contact/ Exit Button

✓

-

Output

\*M8 Intercom version is scheduled to be released in the second half of 2022.

# Access Control

## C2 Series

Versatile Standalone Access & Time Attendance Control Terminal



### Multi-Smartcard Reader

Support 125kHz or 13.56MHz RFID including MIFARE, MIFARE Plus, DESFire, FeliCa, LEGIC, EM, and NFC.



### Communicates with Smartphones

With Anviz Control Protocol (ACP). Any data exchange between the terminal and the smartphone is heavily encrypted and eliminating the possibility of data hacking.



### Mullion-type Design

C2 Series mounts easily with a small access control terminal that can easily be installed on a door frame.



### IP65 Dust & Water Proof

C2 Series is designed to be used indoor and outdoor applications coupled with IP65 ingress protection.



### PoE Easy Installation

Support power sourcing over Ethernet cable compliance to IEEE802.3af standard, to provide users with lower installation cost, simpler cabling, and lower maintenance cost.



### Development Tools

We provide value-added integrations with Anviz new V2.0 SDK and API and offer support services to technology partners with full TCP/IP communication mode and the new C language is compiled into a dynamic library, which is compatible with various operations.

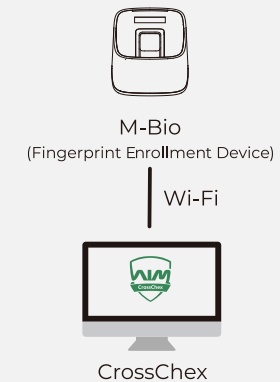
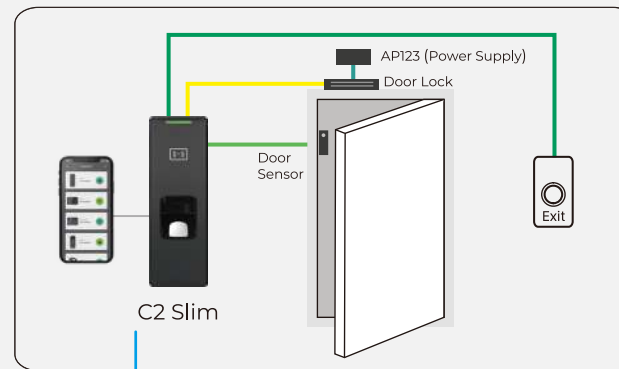
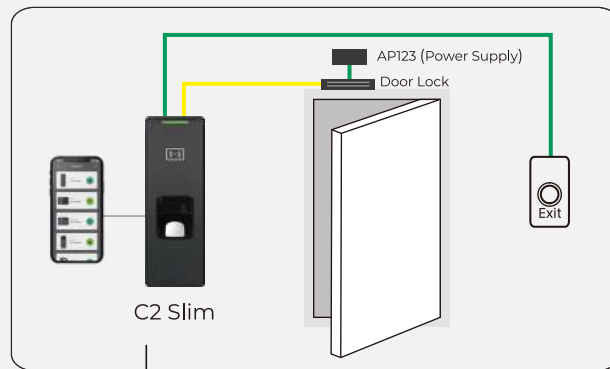

— Output — Input — Relay





C2 SR



C2 KA





C2 Slim



C2 Pro

TA

# Specification Comparison

Product				
Product Name		C2 SR	C2 KA	
Identification Mode		Card	Card, Password	
RFID Options		125kHz EM & 13.56MHz MIFARE	125kHz EM & 13.56MHz MIFARE	
Capacity	Max. Users	-	10,000	
	Max. Cards	-	10,000	
	Max. Logs	-	100,000	
Function	Time Attendance Mode	-	-	
	Group, Time Zone	-	16 groups, 32 time zones	
	Work Code	-	-	
	Short Message	-	-	
	WebServer	-	√	
	Record Auto Inquiry	-	-	
	Daylight Saving	-	√	
	Voice Prompt	-	Voice	
	Multiple Language	-	-	
	Software	-	CrossChex Standard	
	CPU	32-bit Processor	Linux 1.0 GHz	
	Sensor	-	-	
	Scanning Area	-	-	
Hardware	Display	-	-	
	Keypad	-	Physical Button	
	Dimensions(W x H x D)	50x159x25mm (1.97x6.26x0.98")	50x159x25mm (1.97x6.26x0.98")	
	Working Temperature	-10°C~60°C (14°F~140°F)	-10°C~60°C (14°F~140°F)	
	Humidity	20% to 80%	20% to 90%	
	PoE	-	IEEE802.3af/at	
	Power Input	DC12V	DC12V	
	IP Grade	IP65	IP65	
	I/O	TCP/IP	-	√
		RS232	-	-
RS485		√	√	
USB Host		-	-	
Wi-Fi		-	√	
Bluetooth		-	√	
Relay		-	√	
I/O		-	Door Contact/ Exit Button	
Tamper Alarm		-	√	
Wiegand		Output	IN & OUT	



**C2 Slim**

Finger, Card

125kHz EM & 13.56MHz MIFARE Card  
HID iCalss(Optional)

3,000

3,000

50,000

-

16 groups, 32 time zones

-

-

✓

-

✓

Voice

-

CrossChex Standard

Linux 1.0 GHz

AFOS Touch Active Sensor

22mmx18mm (0.87x0.71")

-

-

50x159x25mm (1.97x6.26x0.98")

-10°C~60°C (14°F~140°F)

20% to 90%

IEEE802.3af/at

DC12V

IP65

✓

-

✓

-

✓

✓

✓

Door Contact/ Exit Button

✓

IN & OUT



**C2 Pro**

Finger, Password, Card

125kHz EM & 13.56MHz MIFARE Card  
HID iCalss(Optional)

10,000

10,000

100,000

8

16 groups, 32 time zones

8 digits

50

✓

✓

✓

Voice

✓

CrossChex Standard & CrossChex Cloud

Dual Core 1.0 GHz

AFOS Touch Active Sensor

22mmx18mm (0.87x0.71")

3.5" TFT

Physical Button

140x190x32mm (5.51x7.48x1.26")

-10°C~60°C (14°F~140°F)

0% to 90%

IEEE802.3af/at

DC12V

-

✓

✓

✓

✓

✓

-

✓

-

-

Output

# Time and Attendance

Anviz time and attendance solution provide a simple way to track and manage employee attendance, dedicated to saving your business money through employee time management, reducing administrative costs of time and attendance data collection and processing, thereby increasing overall productivity and profitability.

 Biometric-based time and attendance management (Facial, fingerprint scanner, RFID and PIN) offer versatile punching options, provides accurate employee data that eliminates buddy punching and time theft, while also saving you money.

 Flexible, scalable, and customizable schedule management to suit any business, no matter what size.

 High-impact and personalized reporting which makes you feel intuitive with daily processes.

 Time and attendance cloud support provide hassle-free workforce management, easily track and manage employee attendance from anywhere, anytime.

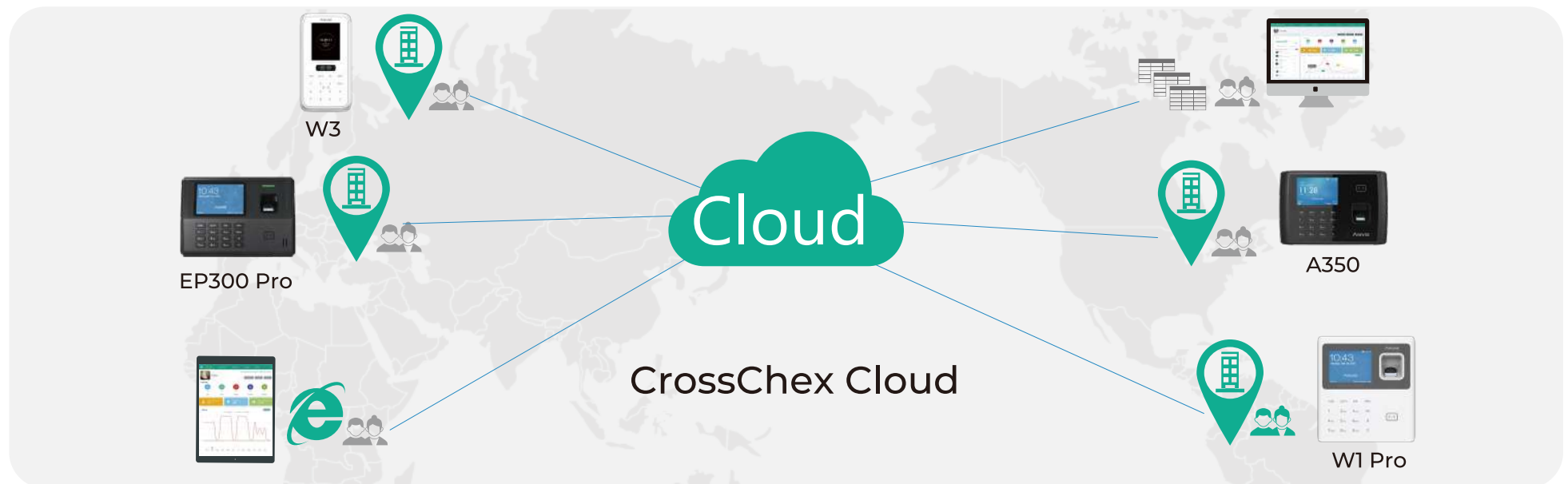

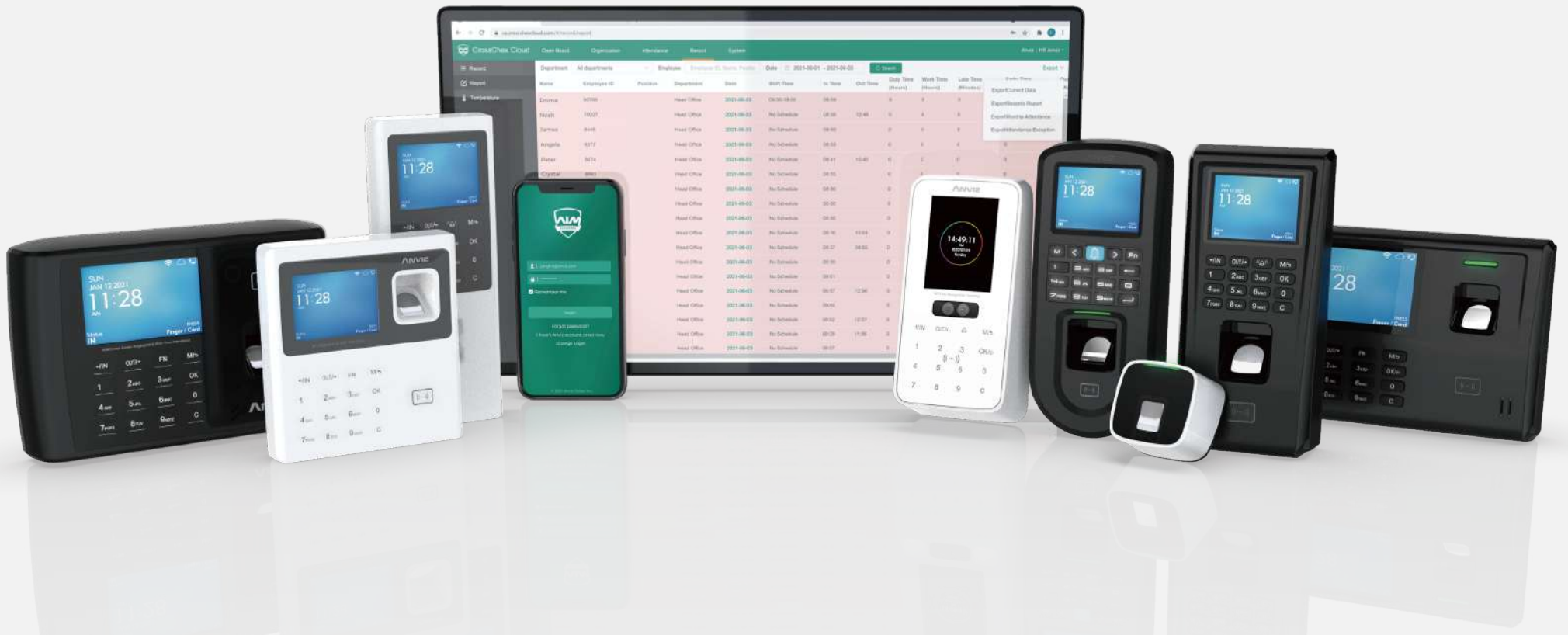

A350



W1 Pro



W2 Pro

AC



W3

AC



VF30 Pro

AC



M-Bio





EP30

AC



EP300 Pro

# Specification Comparison

Product				
Product Name		W1 Pro	W2 Pro	W3
General	Identification Mode	Finger, Password, Card	Finger, Password, Card	Face, Password, Card
	RFID Options	125kHz EM(Standard), 13.56MHz MIFARE(Optional)	125kHz EM(Standard), 13.56MHz MIFARE(Optional)	125kHz EM(Standard)
	Max. Users	3,000	3,000	200
Capacity	Max. Cards	3,000	3,000	200
	Max. Logs	100,000	100,000	50,000
	Time Attendance Mode	8	8	8
Function	Group, Time Zone	-	16 groups, 32 time zones	-
	Work Code	6 digits	6 digits	-
	WebServer	√	√	√
	Record Auto Inquiry	√	√	√
	Daylight Saving	√	√	√
	Voice Prompt	Voice	Voice	Voice
	Multiple Language	√	√	√
	Software	CrossChex Standard & CrossChex Cloud	CrossChex Standard & CrossChex Cloud	CrossChex Standard & CrossChex Cloud
	Sensor	AFOS Touch Active Sensor	AFOS Touch Active Sensor	Dual Cameras
Hardware	Display	2.8' TFT LCD	2.8' TFT LCD	2.8' TFT LCD
	Keypad	Touch Active	Touch Active	Touch Active
	Dimensions(W x H x D)	130x140x30mm (5.11x5.51x1.18")	204x80x30mm (8.03x3.15x1.18")	105x72x46mm (4.13x2.83x1.81")
	Working Temperature	-10°C~60°C (14°F~140°F)	-10°C~60°C (14°F~140°F)	-10°C~60°C (14°F~140°F)
	Humidity	20% to 90%	20% to 90%	20% to 90%
	Power Input	DC5V	DC12V	DC12V
	Battery	Optional	Optional	-
	TCP/IP	√	√	√
I/O	RS485	-	√	-
	USB Host	√	√	√
	Wi-Fi	Optional	Optional	Optional
	Bluetooth	-	-	-
	4G	-	-	-
	Relay	-	√	√
	I/O	-	Door Contact/ Exit Button /Bell	Door Contact/ Exit Button /Bell
	Tamper Alarm	-	√	-
	Anti-pass back	-	√	-
Wiegand	-	IN & OUT	-	



A350	EP300 Pro	EP30	VF30 Pro	M-Bio
Finger, Password, Card	Finger, Password, Card	Finger, Password, Card	Finger, Password, Card	Finger, Card
125kHz EM(Standard), 13.56MHz MIFARE(Optional)	125kHz EM(Optional)	125kHz EM(Optional), 13.56MHz MIFARE(Optional)	125kHz EM(Standard), 13.56MHz MIFARE(Optional)	125kHz EM & 13.56MHz MIFARE
3,000	3,000	3,000	3,000	3,000
3,000	3,000	3,000	3,000	3,000
100,000	100,000	100,000	100,000	100,000
8	8	8	8	-
-	-	16 groups, 32 time zones	16 groups, 32 time zones	-
6 digits	6 digits	6 digits	6 digits	-
✓	✓	✓	✓	✓
✓	✓	✓	✓	-
✓	✓	✓	✓	-
Voice	Voice	Voice	Voice	Voice
✓	✓	✓	✓	-
CrossChex Standard & CrossChex Cloud	CrossChex Standard & CrossChex Cloud	CrossChex Standard & CrossChex Cloud	CrossChex Standard & CrossChex Cloud	CrossChex Standard & CrossChex Cloud
AFOS Touch Active Sensor	AFOS Touch Active Sensor	AFOS Touch Active Sensor	AFOS Touch Active Sensor	AFOS Touch Active Sensor
2.8" TFT LCD	3.5" TFT LCD	3.5" TFT LCD	2.4" TFT LCD	1.18" OLED
Touch Active	Physical Button	Physical Button	Physical Button	-
204x139x38mm (5.11x5.51x1.18")	185x130x35mm (7.28x5.12x1.38")	165x76x35mm (6.50x2.99x1.38")	80x180x40mm (3.15x7.09x1.57")	60x60x50mm (2.36x2.36x1.97")
-10°C~60°C (14°F~140°F)	-10°C~60°C (14°F~140°F)	-10°C~60°C (14°F~140°F)	-10°C~60°C (14°F~140°F)	-10°C~60°C (14°F~140°F)
10% to 90%	20% to 90%	20% to 90%	20% to 90%	20% to 90%
DC5V	DC5V	DC12V	DC12V & PoE IEEE802.3af/at	USB
Optional	Optional	-	-	✓
✓	✓	✓	✓	-
-	-	✓	✓	-
✓	✓	-	-	-
Optional	Optional	Optional	Optional	Standard
Optional	Optional	-	-	Standard
Optional	-	-	-	-
✓	-	✓	✓	-
-	-	Door Contact/ Exit Button	Door Contact/ Exit Button /Bell	-
-	-	✓	✓	-
-	-	✓	✓	-
-	-	Output	IN & OUT	-



Distributed by:



**Anviz Global Inc.**

32920 Alvarado-Niles Rd Ste 220, Union City, CA 94587 | Toll-free: 1-855-268-4948 | sales@anviz.com | www.anviz.com

©2022 Anviz Global Inc. All right reserved. Product specifications and availability are subject to change without notice. For the most up-to-date information, please visit [www.anviz.com](http://www.anviz.com)